



ViewStation V.35

QuickStart



POLYCOM[®]
Advanced Teleconferencing Solutions

1.



2.



3.

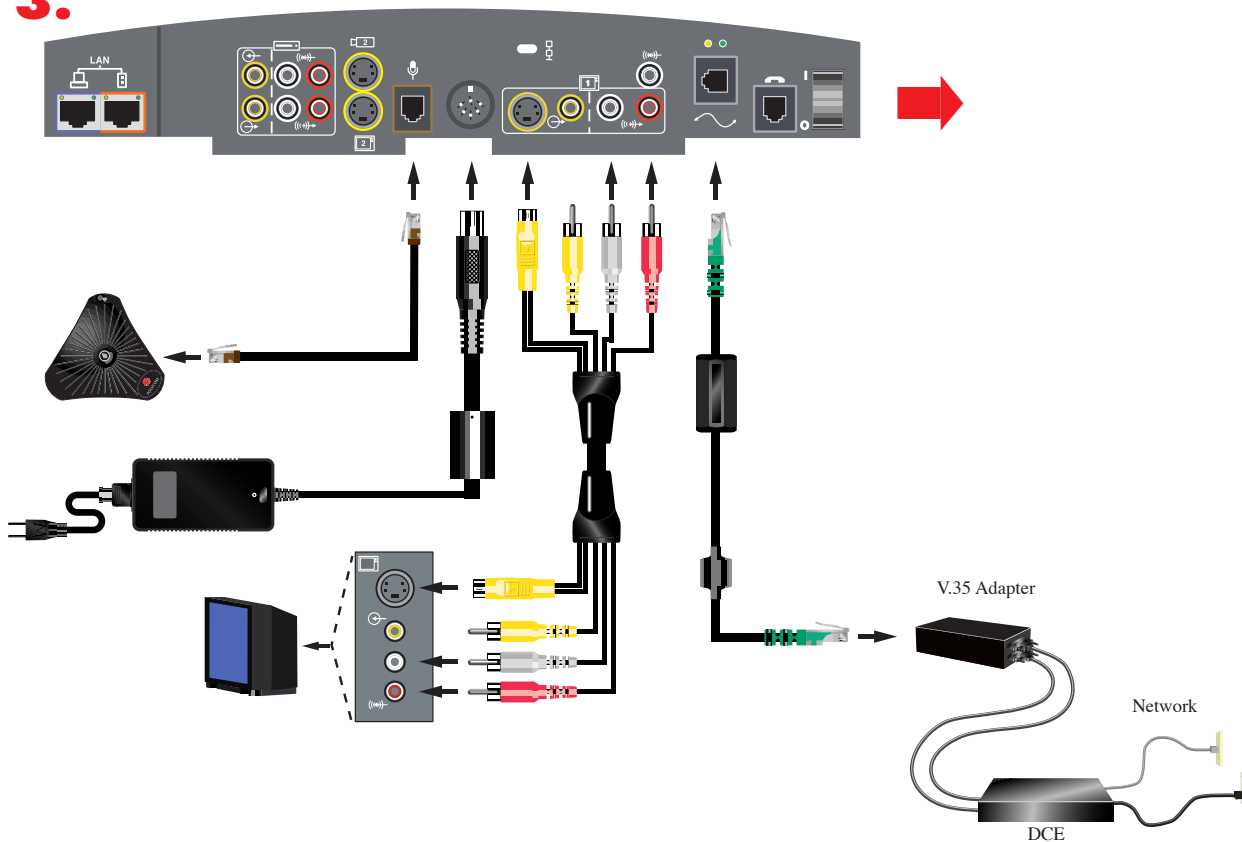

4.

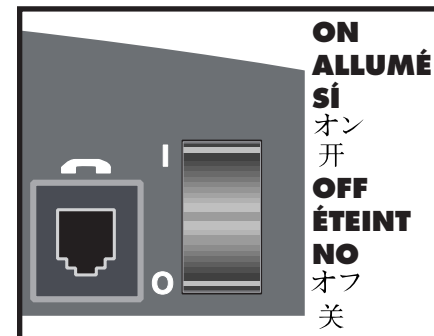

5.



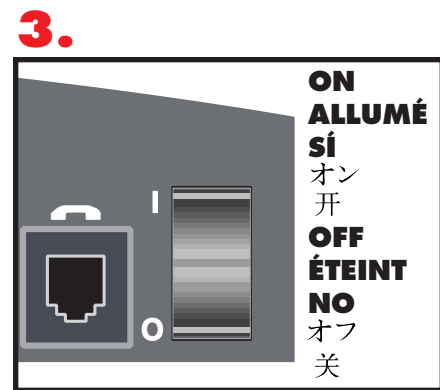
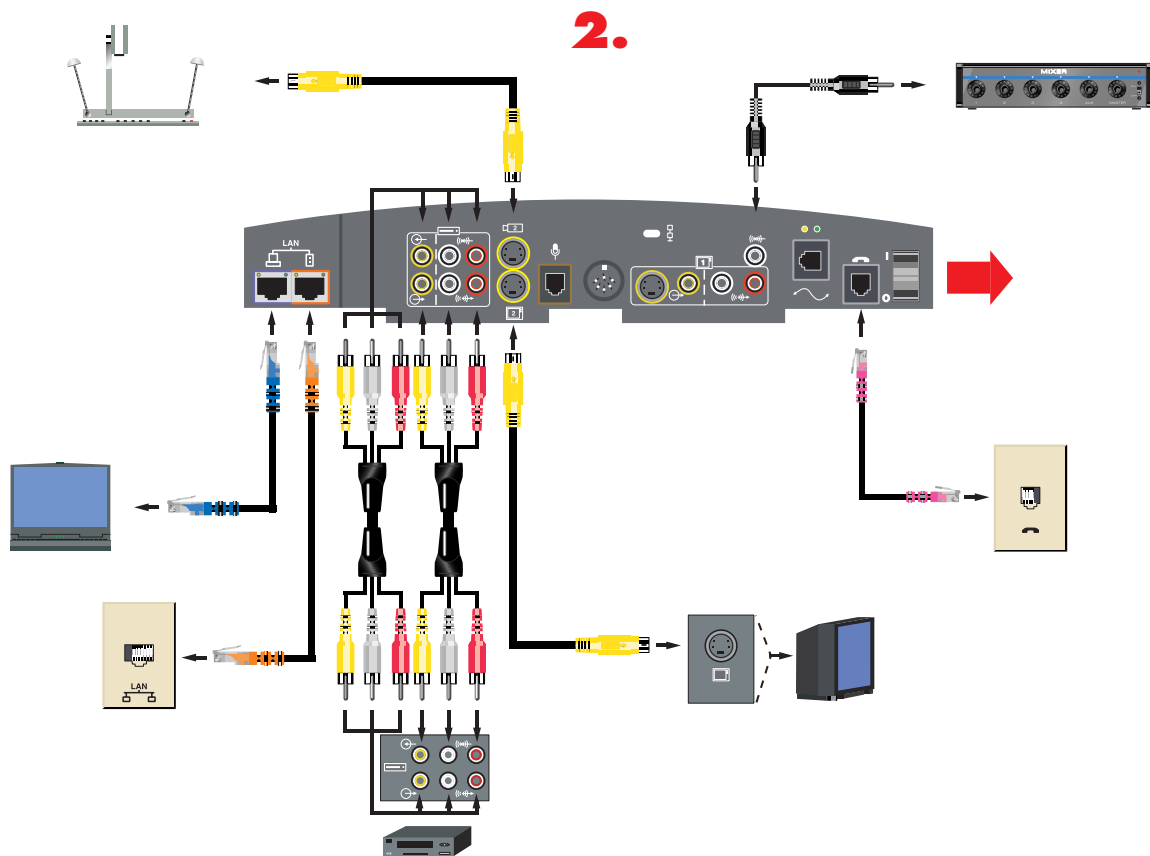

VideoCall Appel vidéo composé manuellement / Llamada manual de video / 手動ビデオコール / 视频拨叫

1.



2.



3.

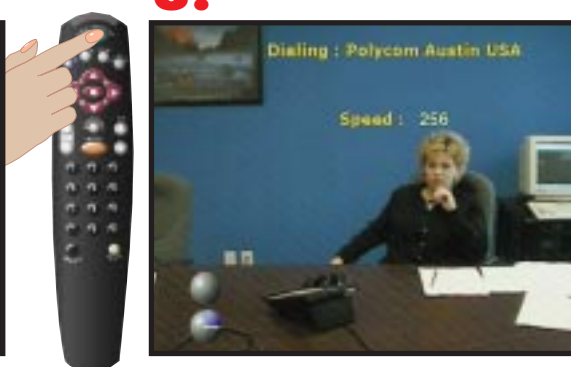

4.



SpeedDial Appel à composition rapide / Selección rápida de llamada / スピードダイヤル / 快速拨号

1.



2.



3.



4.





1. FarCamera/Caméra lointaine/Cámara lejana/
ファーカメラ/ 远程摄像机

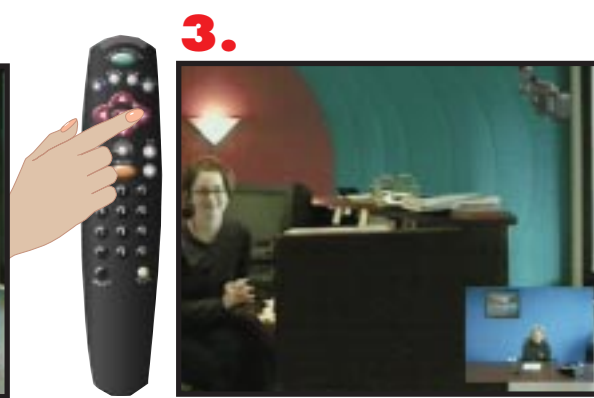

1. NearCamera/Caméra proche/Cámara cercana/
ニアカメラ/近程摄像机



2.

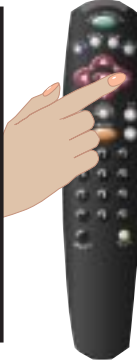

3.

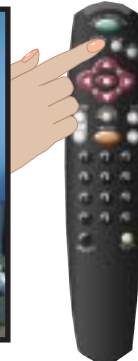

4.

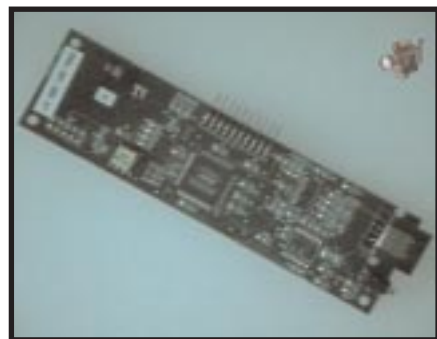

1. FarCamera/Caméra lointaine/Cámara lejana/
ファーカメラ/远程摄像机



2.



3.

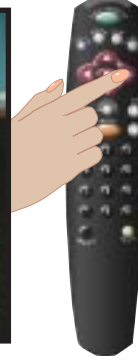
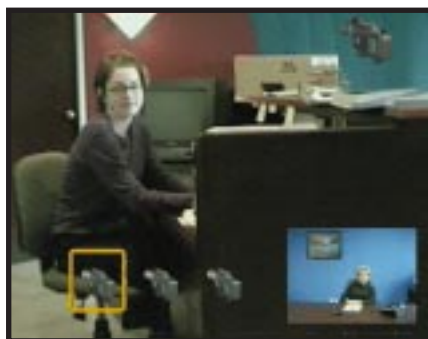

4.





1.

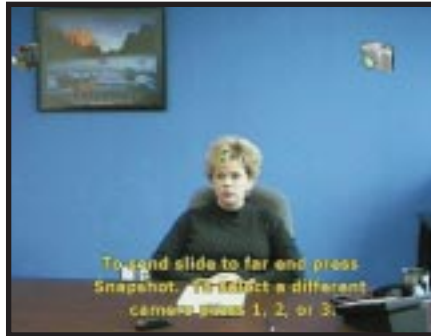

2.



See your ViewStation User's Guide for descriptions of the following advanced features:

- Setting Camera Presets
- Organizing your Address Book
- Using your Document Camera and VCR
- Data Conferencing
- Remotely Managing your ViewStation

Consulter le manuel de l'utilisateur de votre ViewStation pour les caractéristiques suivantes:

- Installation des pré-réglages de la caméra
- Organization de votre Carnet d'adresses
- Utilisation de votre caméra à documents et votre VCR
- Conférence de base de données
- Gestion à distance de votre ViewStation

Vea la guía al uso de la ViewStation para las descripciones de las siguientes características superiores:

- Instalación de valores preestablecidos de la Cámara
- Organización de vuestra libreta de direcciones
- Uso de la cámara de documentos y la videogradora

- Conferencia de datos
- Gestión remota de la vuestra ViewStation

次の高度機能の説明は『ViewStation User's Manual』を参照してください。

- カメラプリセットの設定
- アドレスブックの整理
- ドキュメントカメラとVCRの使い方
- データ会議
- ViewStation の遠隔管理

参照 ViewStation

用户指南中对下述高级特性的描述:

- 设置摄像机预设
- 整理号码簿
- 使用文档摄像机和VCR
- 数据会议
- 从远方管理 ViewStation



Polycom, Inc., 2584 Junction Ave., San Jose, CA 95134-1902, U.S.A.
Internet www.polycom.com

Polycom®, ShowStation®, and the Polycom logo design are registered trademarks and ViewStation is a trademark of Polycom, Inc. in the U.S. and various countries.

© 1999 Polycom, Inc. All Rights Reserved. Part No. 1725-08696-001A



1725-08696-001A